

ARTICULATORS

average values

5050 and 5050Plus are non-Arcan average value articulators designed to help dental technicians meet dentists' requests for high precision regardless of the prosthetic technique. A light, stable and ergonomic construction facilitates set-up and work on any models. Additional features guarantee an exact simulation of the condylar path with a high fitting accuracy, giving prosthesis and restorations the necessary occlusion and function throughout the full range of mandibular movements.

5050 can conveniently work with dentures of many different sizes and any electronic pressure polymerizers available on the market. Designed to obtain optimal ergonomics, it offers complete stability when the technician comfortably works at 60° or upside down, in case of class III edentulous patients. The anti-rotational system for the incisal rod ensures that positioning is always correct and accurate, while the back blocking systems allows removing the rod and conveniently working on incisors. When the technique requires starting from one of the upper arches, the mounting plate helps regardless the size of the arch with clear indication of elliptic references.

FEATURES

- stable 60° operation for technician comfort
- ideal for class III patients
- compatible with any pressure polymerizers
- anti-rotation system for incisal rod
- template with 4 elliptic references for lower arch models
- occlusal table with 4 elliptic references for upper arch models
- bearing rod for 180° opening
- hinge rod with anti-shock protection system

TECHNICAL DATA

intercondylar distance	110 mm
condylar inclination fixed at	30°
Bennett angle	0 - 7°
incisal table inclination	10°
distance between mounting plates	87 mm
opening	180°

EQUIPMENT

4 mounting plates	5000-1
2 locking knobs	5011-6



5050

ARTICULATORS

average values

5050Plus is the most versatile articulator that complements Asa Dental laboratory instruments. **5050Plus** is available as a standalone product or as an upgrade of **5050**, with the addition of few accessories. Offering all the standard features of **5050**, with a dedicated mounting plate the articulator becomes the ideal solution for all the techniques based on building the prosthetics on lower arches while a magnetic incisal rod safely prevents undesired alteration of the model during cast solidification. Simple, accurate and ergonomic, **5050Plus** represents our best solution for dental technicians asking for a flexible and reliable average value, non-Arcan articulator.

FEATURES

- stable 60° operation for technician comfort
- ideal for class iii patients
- compatible with any pressure polimerizers
- anti-rotation system for incisal rod
- total stability when working without incisal rod
- template with 4 elliptic references for lower arch models
- occlusal table with 4 elliptic references for upper arch models
- magnetic incisal rod for total stability
- bearing rod for 180° opening
- hinge rod with anti-shock protection system

TECHNICAL DATA

intercondylar distance	110 mm
condylar inclination fixed at	30°
Bennett angle	0 - 7°
incisal table inclination	0°
distance between mounting plates	87 mm
inclined contrast table	24°
opening	180°

EQUIPMENT

4 mounting plates	5000-1
2 locking knobs	5011-6



5050Plus

ARTICULATORS

average values

lightweight anatomic articulator made of aluminum die-casting;
 it can be used following the geometrical laws of medium values (Bonwill triangle);
 fixing according to centric;
 automatic return to the hinge axis with springs;
 anti-shock hinge rod in case articulator falls accidentally;
 bigger size lock screws for mounting plates;
 anatomic back shoulders favour a practical and efficient holding of the articulator

FEATURES

- increased height and width
- more space when using removable stumps systems
- more space for installation of mobile prosthesis with high chewing or big base
- more space when using magnetic plates
- better back entrance
- variable internal working distance
- incisal guide rod and bearing rod for 180° opening are in stainless steel
- stainless steel hinge rod
- anti-shock protection system

TECHNICAL DATA

intercondylar distance	120 mm
condylar inclination fixed at	30°
Bennett angle fixed at	7°
incisal table inclination	10°
distance between mounting plates	90-110 mm
weight	700 gr
opening	180°

EQUIPMENT

2 spacers	5030-29
4 mounting plates	5000-1
2 locking knobs for spacer	5030-6
2 locking knobs for plates	5011-6

ACCESSORIES

face bow	5021
transfer table	5024
occlusal table	5030-2
fast caliper	5033



ARTICULATORS

average values

features 5032 - same features as mod.

5030 plus:

adjustable back rod by registration screw to work without incisal rod by keeping constant trajectories and inclinations during side and back/forward movements; pure translation movement (key and instructions included)

FEATURES

- back rod on the upper side to unchanged back entrance and visibility and easy mechanisms regulation
- hinge rod with pure translation movement allowed

TECHNICAL DATA

intercondylar distance	120 mm
condylar inclination fixed at	30°
Bennett angle fixed at	7°
incisal table inclination	10°
distance between mounting plates	90-110 mm
weight	700 gr
opening	180°

EQUIPMENT

2 spacers	5030-29
2 magnetic mounting plates	5000-1M
2 locking knobs for spacer	5030-6
2 locking knobs for plates	5011-6

ACCESSORIES

face bow	5021
transfer table	5024
occlusal table	5030-2
fast caliper	5033



5032



ARTICULATORS average values

EQUIPMENT

2 mounting plates	5000-1
2 locking knobs for plates	5011-6



5002

occlusor

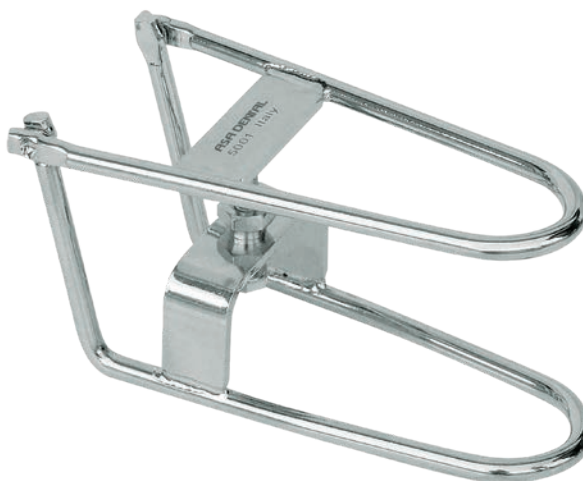

5001

spare parts

mounting plate
die-casting aluminum mounting plate
applicable to articulators

- 5050
- 5050Plus
- 5030
- 5032
- 5002
- 5000
- 5010
- 5011

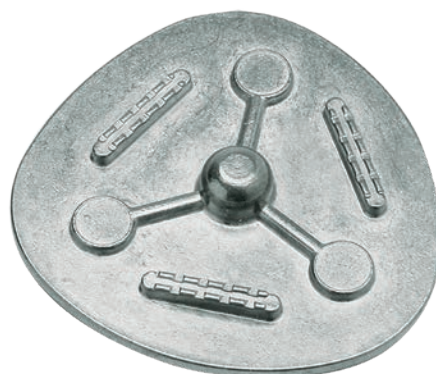

5000-1

ARTICULATORS

spare parts



5000-26
magnet



5000-26

5000-30
magnet holder



5000-30

5000-1M
• die-casting aluminum teflon covered mounting plate
• magnet holder (5000-30)
• magnet (5000-26)

applicable to articulators

5050

5050Plus

5030

5032

5002

5000

5010

5011

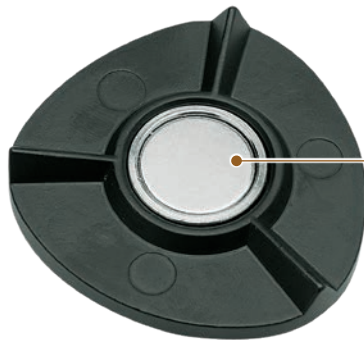

5000-1M



5000-30



5000-26

5000-25
cast fastening washer
for die-casting aluminum
mounting plate
10 pcs / pack



5000-25

5030-29
spacer
applicable to articulators
5030
5032



5030-29

ARTICULATORS

spare parts

5050Plus

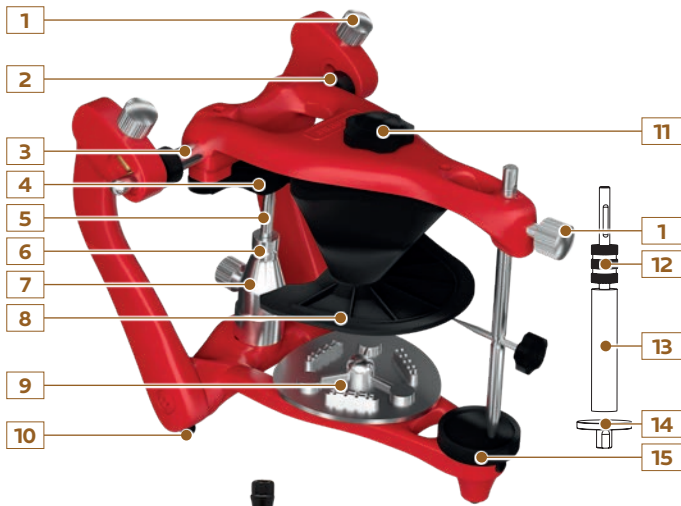

5050

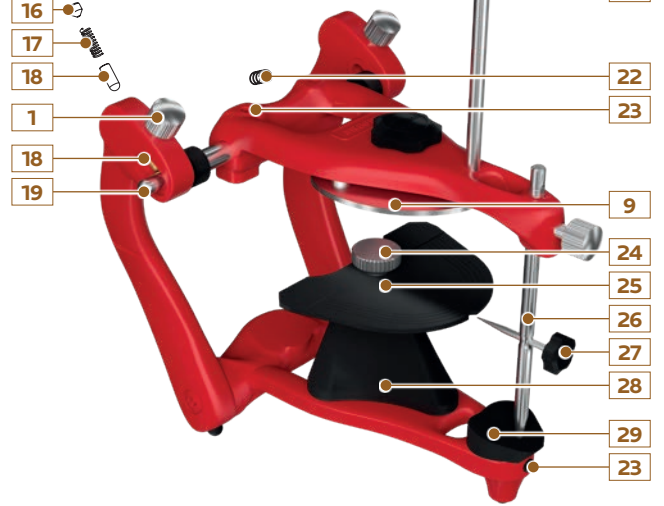

5030/5032

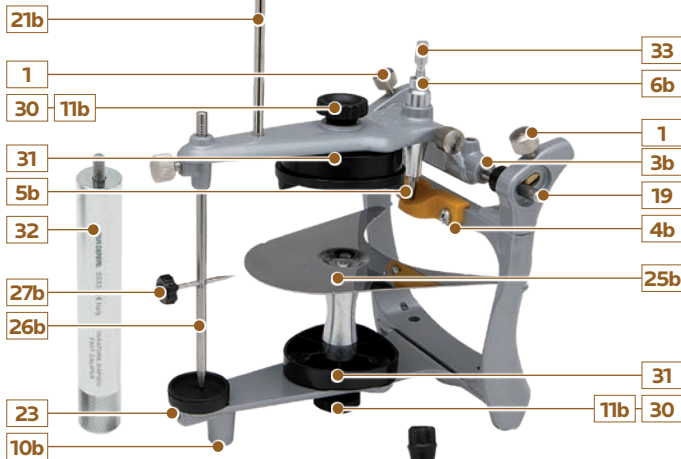

5000/5010

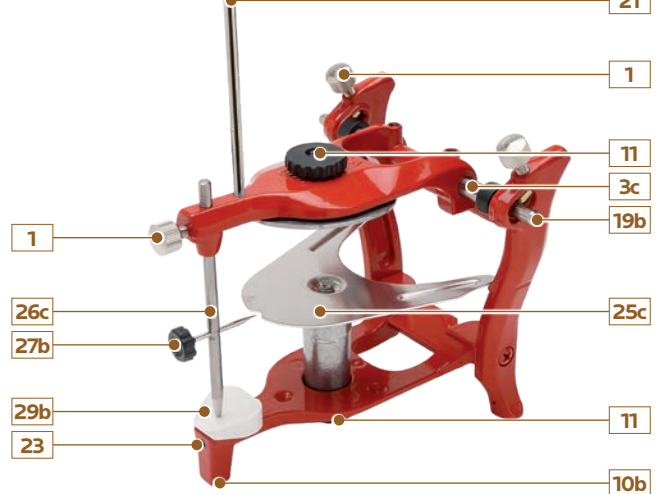

5011

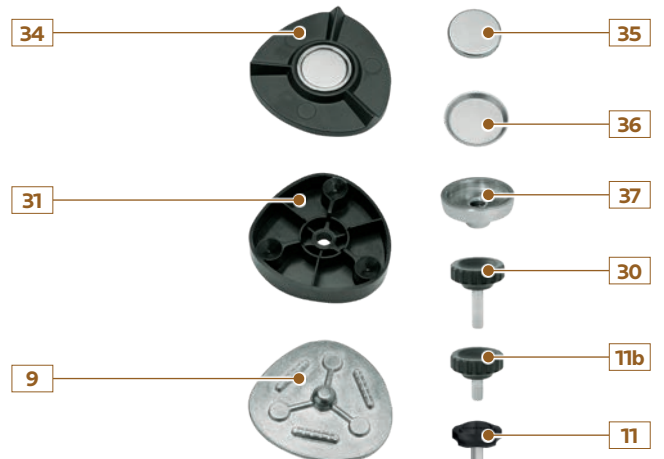
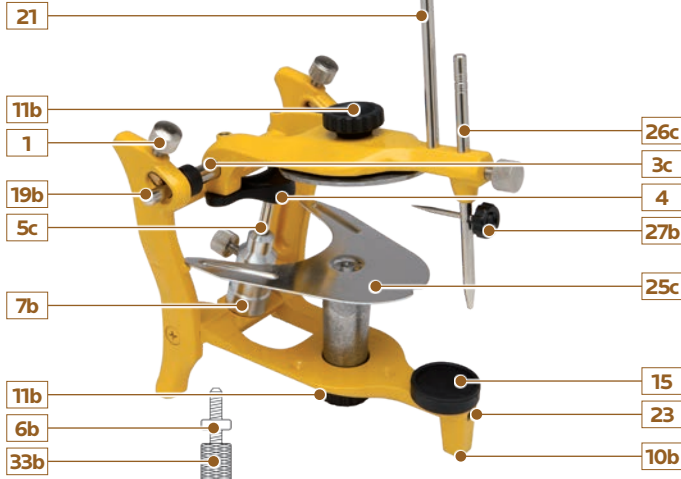

ARTICULATORS

spare parts

		CURRENT MODELS					OLD MODELS		
		5050Plus	5050	5032	5030	5002	5011	5010	5000
1	metallic locking knob	5000-5	5000-5	5000-5	5000-5		5000-5	5000-5	5000-5
2	hinge rod washer	5011-18	5011-18	5011-18	5011-18		5011-18	5011-18	5011-18
3, 3b, 3c	hinge rod	5050-17	5050-17	5032-17	5032-17		5011-17	5011-17	5011-17
4, 4b	inclined contrast table	5011-16		5032-16			5011-16		
5, 5b, 5c	back rod	5050-21		5032-21			5011-21		
6, 6b	adjusting screw locknut	5011-23		5032-23			5011-23		
7, 7b	back rod support	5050-20					5011-20		
8	template	5052	5052						
9	mounting plate	5000-1	5000-1	5000-1	5000-1	5000-1	5000-1	5000-1	5000-1
10, 10b	rubber nubs (6 pcs/pack)	5050-24	5050-24	5000-24	5000-24		5000-24	5000-24	5000-24
11, 11b, 11c	locking knob	5050-6	5050-6	5011-6	5011-6	5000-6	5011-6	5000-6	5000-6
12	rod ferrule	5053-2							
13	magnetic rod	5053-1							
14	table for magnetic rod	5053-3							
12+13+14	magnetic rod kit	5053							
15	incisal guide table (0°)	5011-4		5011-4			5011-4		
16	adjusting screw - side shift	5000-7	5000-7	5000-7	5000-7		5000-7	5000-7	5000-7
17	side shift spring	5000-12	5000-12	5000-12	5000-12		5000-12	5000-12	5000-12
18	side shift cylinder	5000-13	5000-13	5000-13	5000-13		5000-13	5000-13	5000-13
19, 19b	condylar guidance	5030-9	5030-9	5030-9	5030-9		5011-9	5011-9	5011-9
20	rubber cap	5011-11	5011-11	5011-11	5011-11		5011-11	5011-11	
21, 21b	bearing rod	5010-10	5010-10	5030-10	5030-10		5010-10	5010-10	
22	hinge rod spring	5011-19	5011-19	5011-19	5011-19		5011-19	5011-19	5011-19
23	M5 screw - incisal table	5000-18	5000-18	5000-18	5000-18		5000-18	5000-18	5000-18
24	knurled knob for template and occlusal table	5050-4	5050-4						
25, 25b, 25c	occlusal table	5051	5051	5030-2	5030-2		5000-2	5000-2	5000-2
26, 26b, 26c	incisal guide rod	5050-3	5050-3	5030-3	5030-3		5000-3	5000-3	5000-3
27, 27b	incisal pin	5050-8	5050-8	5000-8	5000-8		5000-8	5000-8	5000-8
28	support for occlusal table and template	5050-2	5050-2						
24+25+28	occlusal table assembly (5050-4 + 5051 + 5050-2)	5054	5054						
29, 29b	incisal guide table (10°)		5000-4N		5000-4			5000-4	5000-4
30	locking knob for spacer			5030-6	5030-6				
31	spacer			5030-29	5030-29				
32	fast caliper			5033	5033				
33, 33b	adjusting screw			5032-22			5011-22		
34	magnetic mounting plate - complete	5000-1M	5000-1M	5000-1M	5000-1M	5000-1M	5000-1M	5000-1M	5000-1M
35	magnet	5000-26	5000-26	5000-26	5000-26	5000-26	5000-26	5000-26	5000-26
36	cast fastening washers (10 pcs/pack)	5000-25	5000-25	5000-25	5000-25	5000-25	5000-25	5000-25	5000-25
37	magnet holder	5000-30	5000-30	5000-30	5000-30	5000-30	5000-30	5000-30	5000-30